

Rodamiento oscilante dos hileras de rodillos

22215-E1-C4-FAG

22215-E1-C4-FAG

 **LE BON ROULEMENT**

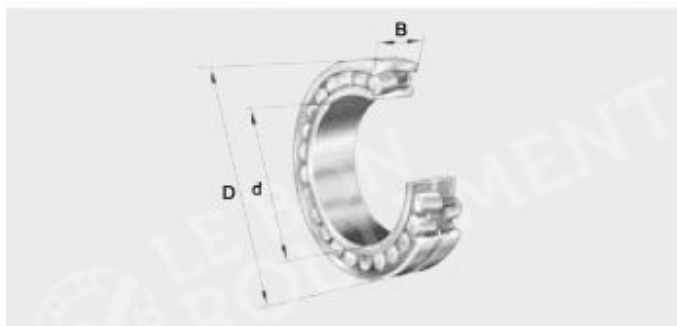

FAG	x-life	Euro	~kg	d mm	D mm	B mm	
22215-E1	XL	303,50	1,72	75	130	31	1



Rodamiento oscilante dos hileras de rodillos 22215-E1-C4-FAG

Caractéristique	Valeur
d - Diámetro interior (mm)	75
D - Diámetro exterior (mm)	130
C - Espesor (mm)	31
Marca	FAG
Tipo del rodamiento	Con rodillos oscilantes
Juego	Muy alta velocidad (C4)
Tipo de sellado	No estanco
Tipo de jaula	Acero
Agujero	Cilíndrico/a
Rodamiento serie	22200
Unidad de venta	pieza

